

# 센서 스위치

## 주문형식 (예)

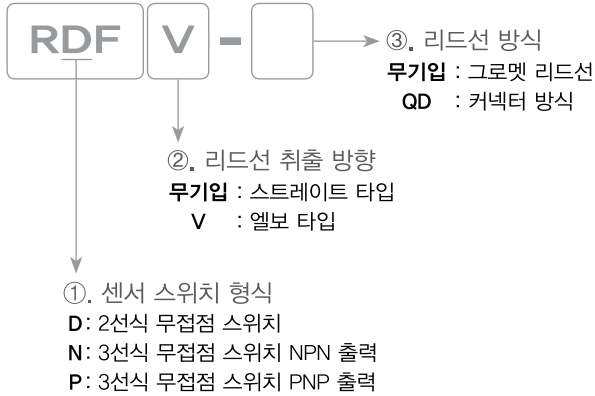

### ※. QD 커넥터

- 2선식

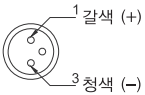

- EQD 2선식



- 3선식

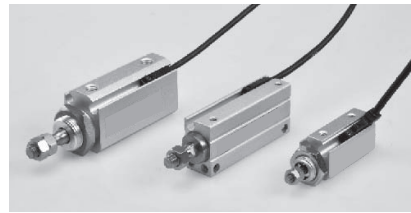
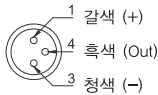

## 치수도

### RDF / RNF / RPF RDF-QD / RNF-QD / RPF-QD

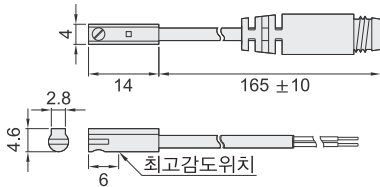

### RDFV / RNFV / RPFV RDFV-QD / RNFV-QD / RPFV-QD

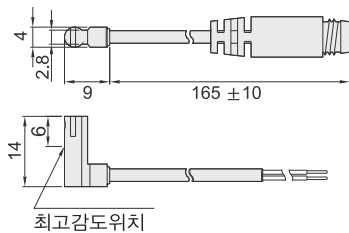

## 실린더 취부 방법

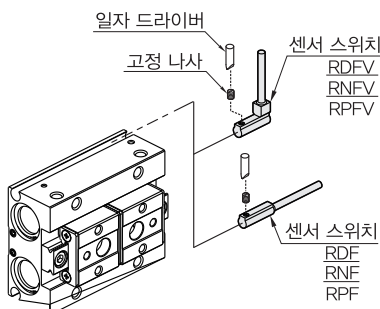

※ 적용실린더 : PCFB, PCMJF

## 사양

항목	형식	RDF / RDFV	RNF / RNFV	RPF / RPFV
배선방식		2선식	3선식	
사양		무접점 스위치		
스위치 방식		-	NPN 출력, N/O	PNP 출력, N/O
사용전압범위		10~28V DC	4.5~28V DC	
부하전류		4~20mA max.	50mA max.	
접촉범위		0.6W max.	1.5W max.	
소비전류		-	10mA / 24V DC max. (스위치 활성화 시)	
내부강하전압		3.5V max.	0.5V / 50mA max.	
절연전류		0.8mA max.	0.01mA max.	
동작표시		ON 동작시 LED 램프 점등		
동작표시등		적색 LED		
리드선		2.6φ, 2C, PVC	2.6φ, 3C, PVC	
리드선길이		1m, 2m, 3m		
보존온도범위		-10~70°C (不凍)		
내충격		50G		
내진동		9G		
보호구조		IEC 529 IP67		
중량		12.8g (리드선 길이 1m), 23.8g (리드선 길이 2m)		
내부회로도				